



PORSCHE



# The new Taycan

Soul, electrified.

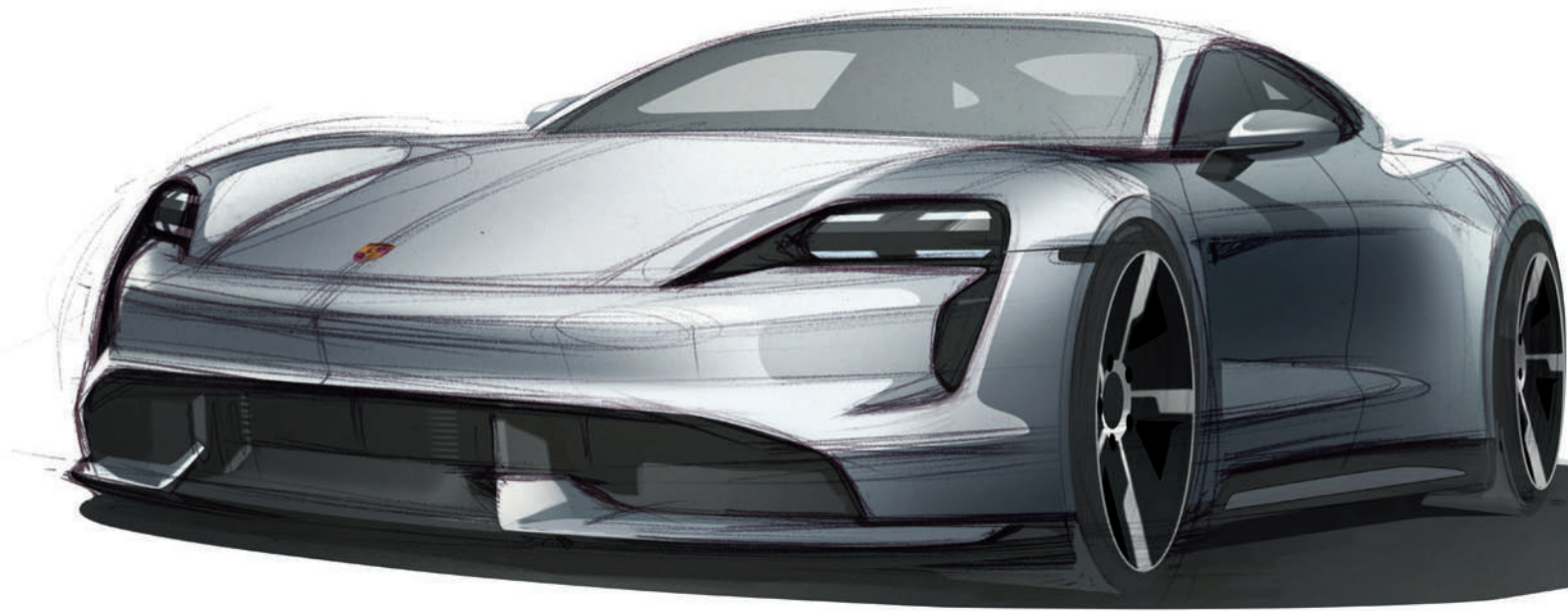

European models shown. Some options may not be available in the U.S. Some items of equipment are available as extra-cost options only. The availability of models and options may vary from market to market due to local restrictions and regulations. For information on standard and optional equipment, please consult your authorized Porsche dealer. All information regarding construction, features, design, performance, dimensions, weight, fuel consumption and running costs is correct to the best of our knowledge at the time of going to print (10/2019). Porsche reserves the right to alter specifications, equipment and delivery scopes without prior notice. Colors may differ from those illustrated. Errors and omissions excepted. More information in various languages is available at [www.porsche.com/BEV](http://www.porsche.com/BEV)

## Contents.

- 6 **Soul, electrified.**
- 16 **The Taycan**
- 20 Models
- 22 Design
- 26 Cockpit
- 28 Performance
- 32 Chassis
- 34 Important Limitations of Assistance Systems
- 36 **Charging**
- 40 **Porsche Connect**
- 42 **Personalization**
- 46 **Technical data**



Discover the soul of the Taycan using the 'Porsche AR Visualizer' app. Wherever this symbol appears, you can unlock exciting digital content by activating the 'Scan image' function.



What makes an electric sports car the first all-electric Porsche?



A crest that lends  
metal a soul.

# A battery that stores goosebumps.

The Taycan carries a legacy that is reflected by performance. The latest drive technology ensures that its performance can be repeatedly reproduced: two permanent-magnet synchronous motors (PSMs) catapult the Taycan Turbo S with up to 560kW (750 HP) Overboost Power with Launch Control from 0–60 mph in 2.6 seconds. With a standing start of 1.2g, it accelerates faster than the force of gravity for the first few yards – making it faster than a skydiver in free fall.





IONITY



IONITY

IONITY

IONITY

A cable with the power  
to fuel dreams.

The Porsche soul stands for performance. In every respect. As demonstrated by the Taycan, even when charging: its 800-volt architecture accepts charge power of up to 270kW.

The image shows the interior of a Porsche Taycan, focusing on the driver's side. The steering wheel is black with the Porsche crest in the center. The dashboard is a wide, curved digital display showing various vehicle metrics and settings. The center console has a gear selector and handbrake. The passenger side also features a digital display with a grid of application icons. The car is parked on a street, with a building and pedestrians visible through the windshield.

# A display that portrays emotions.

The Porsche Advanced Cockpit in the Taycan is characterized by pioneering technologies and offers up to four displays. The fully digital curved display is the driver's main focus. But what really distinguishes the Taycan is the feeling behind the wheel: the familiarity of a Porsche coupled with the irresistible beating of your heart.



The Taycan.

Its heart: electric.  
Its soul: Porsche.

The Taycan is ready for the future, thanks to its innovative concept. It is characterized by the features that have always been decisive for any Porsche: pure emotion and maximum driving pleasure.

As you approach the Taycan in your garage, nothing stands in the way of your personal driving experience. The vehicle is fully charged, already knows your destination – transferred in advance via the Porsche Connect app – has planned the appropriate route and the cabin is conditioned to the correct temperature and ready for you to climb in.

You are instantly greeted by the familiar Porsche feeling – coupled with the latest technologies. The Porsche Advanced Cockpit boasts a fully digital 16.8-inch curved display, integrated 8.4-inch center console control panel and 10.9-inch central display. Here, under 'Notifications', you'll find constantly updated information that is relevant to you. If you prefer to focus all your senses entirely on the road ahead, simply switch to the minimized view and only driving-relevant content will be displayed, such as speed and driving mode. As pure as the sports car experience behind it.

Then you put your foot on the pedal – and the Porsche soul of the Taycan is revealed: two permanent magnet synchronous motors producing 460kW (616 HP) in the Taycan Turbo S unleash their full power from the start and allow acceleration that can be repeatedly reproduced. The low center of gravity ensures exceptional cornering that instantly sets your pulse racing – just as you would expect of a Porsche.

As well as design and performance, the focus is also on comfort and range. If required, the car can plan your route, minimizing the time taken and making long-distance journeys more comfortable. Fast-charging options make stops short – using the 800-volt architecture, you can charge your car in roughly 22.5 minutes under optimum conditions<sup>1)</sup>.

The intelligent Porsche Recuperation Management (PRM) is self-regulating or can be actively set by the driver – depending on the situation. Thanks to extremely efficient recuperation, valuable miles are also recovered while driving. For both sporty and efficient performance – as is typical of Porsche.

So nothing stands in the way of your next spin.

1) Optimum conditions: CCS fast-charging pedestal with >270kW, >850V, battery temperature 86°F to 95°F and initial charge status 5%.



A day in the Taycan.



# Models.

## **Taycan Turbo S**

- Up to 460kW (616 HP) power output
- Up to 560kW (750 HP) Overboost Power with Launch Control
- 774 lb-ft. maximum torque with Launch Control
- 0 to 60 mph in 2.6 seconds with Launch Control
- Top track speed of 161 mph
- Performance Battery Plus

## **Taycan Turbo**

- Up to 460kW (616 HP) power output
- Up to 500kW (670 HP) Overboost Power with Launch Control
- 626 lb-ft. maximum torque with Launch Control
- 0 to 60 mph in 3.2 seconds with Launch Control
- Top track speed of 161 mph
- Performance Battery Plus

Visit [www.porsche.com/taycan-highlights](http://www.porsche.com/taycan-highlights) to watch the Taycan launch film.

Puristic, expressive, timeless. Three attributes that describe every Porsche – and especially this one, which takes our DNA into a new automotive era.

The all-electric drive structure of the Taycan provides additional space that we have consistently exploited. The compact size of the front electric motor unit allows an extremely flat hood design, resulting in the flat hood and pronounced fenders that are typical of Porsche.

Vertical air intakes ahead of the front wheels – so-called **aircurtains** – also improve the aerodynamics, by guiding incoming air over the wheels like a curtain, reducing turbulence. Directly above these is the highlight of the front: **four-point LED headlights** with Matrix Design that combine all the light functions in a single component and appear to be floating.

The silhouette is characterized by a dynamic, flat flyline. Flush, **automatically extending door handles** open the vehicle interior with its deep, sporty seating position.

There are two roof options: the contoured variant made of lightweight aluminum with an indentation in the middle creates a shape that is known to us from

motorsport. Alternatively, a **panoramic fixed glass roof** provides an open, airy feeling. (Standard aluminum roof with contoured design not available until MY2021.)

The rear design features a seamless light strip, as well as the **'Porsche' logo in glass look**. Above this is the adaptive three stage rear spoiler, a fundamental component of **Porsche Active Aerodynamics (PAA)**.

The cabin tapers backwards and the rear fenders are extremely pronounced, as is typical of Porsche. And because there is no exhaust system, the Taycan does not need any tailpipes: leaving more room for a seamless rear diffuser with a sporty, slatted design. A car that reflects the future – and yet instantly reveals the Porsche soul.



## Exterior design.

Visit [www.porsche.com/taycan-design](http://www.porsche.com/taycan-design) to watch the design film.



# Interior design.

From the outside, it is instantly clear that this car is a Porsche. And in the interior, you can also sense distinctive Porsche genes in the new Taycan. The interior architecture is sporty, minimalist and clear; the rising center console is particularly eye-catching and appears to be floating.

The ascending center console underlines the deep, sporty position of the driver's seat. This takes the form of a 14 or optionally 18-way adjustable seat<sup>1)</sup> with integrated headrests. Recesses in the design of the battery integrated into the underbody also ensure an adequate level of comfort for rear passengers.

Behind the wheel, you feel that the Taycan has been tailor-made for you. While your front and rear passengers enjoy an equally comfortable, sporty ride on lightweight seats with solid lateral support. On request, your Taycan can also be fitted with a 2+1 rear seating configuration.

If the standard **multifunction sport steering wheel** is not sporty enough, you can maximize the motor-sport feel with the optional **multifunction GT sport steering wheel**<sup>2)</sup>: it features a mode switch, as well as a top center marking.

For the interior, choose between **smooth-finish leather**, naturally treated **Olea club leather** and a **leather-free interior** in various colors. We also offer trim in Aluminum, Carbon Fiber or Paldao Wood. Accent packages enable selected interior details to be personalized, giving your vehicle an individual signature. As standard, the Taycan also comes with **ambient lighting** that illuminates the interior.

The innovative **Advanced Climate Control** air conditioning (**dual or optional four-zone**) may not be visible, but is certainly noticeable: slat-free vents enable precise airflow and distribution.

The front trunk is great for smaller items like briefcases and bookbags. While the rear trunk offers 12.9 cu.ft. of storage space that can be flexibly expanded, thanks to the individually folding rear seat backrests.

The Porsche feeling in every seat – for all your senses, as soon as you climb in.

<sup>1)</sup> Standard on the Taycan Turbo S.

<sup>2)</sup> In conjunction with the Sport Chrono Package; standard on the Taycan Turbo S.

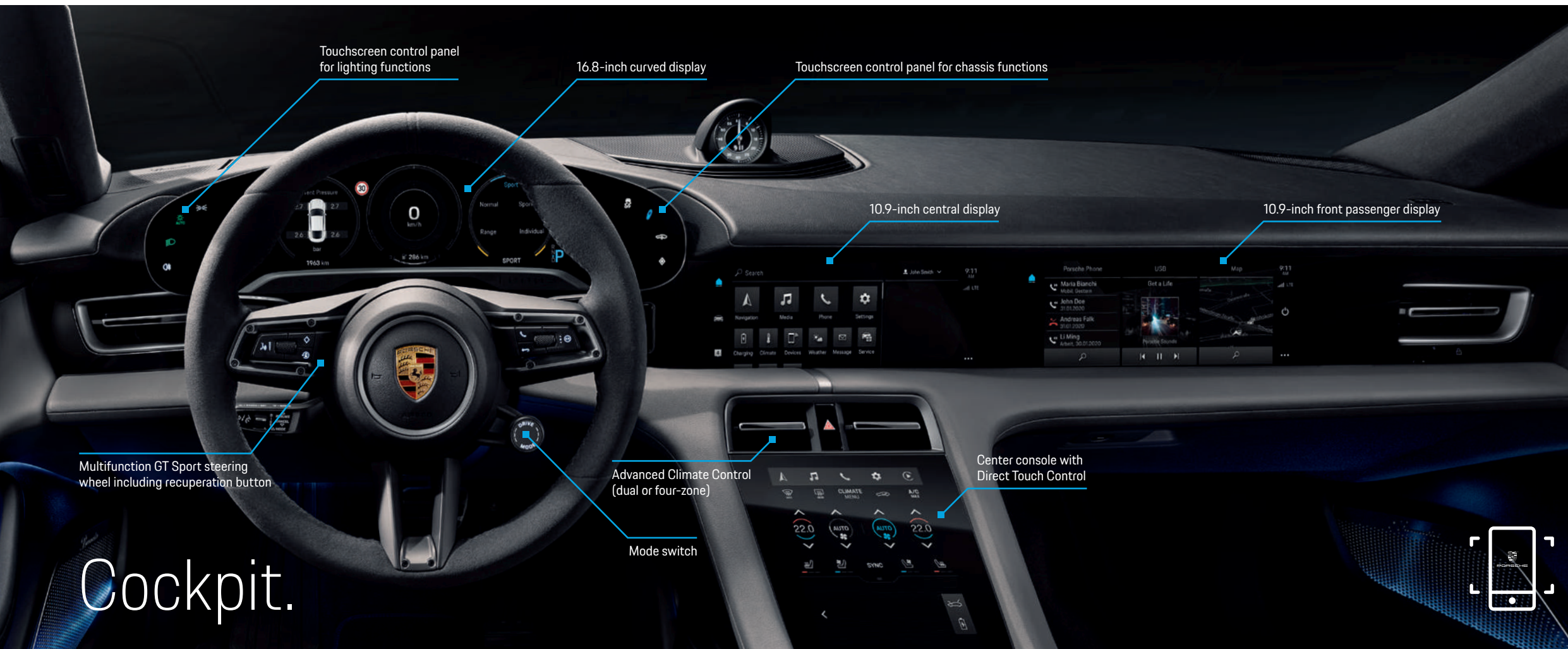

# Cockpit.

We call the Taycan cockpit 'Advanced'. Because it has many pioneering features. It uses technology to increase its simplicity – while providing inspiration.

Physical buttons have been almost entirely replaced by digital ones. Making the interior look extremely tidy. The same principle of tidiness also applies to the displays, of which there are up to four – intuitive, distraction-free and easy to use. As you would expect of a Porsche. Simply climb in, select the D setting and drive off. If you prefer to start your Taycan manually, the ignition button is on the left – because here too, we are true to our roots.

The arrangement is also driver-focused, as is typical of Porsche: the instrument cluster is the center of attention, consisting of a **16.8-inch curved display** and surrounded by control panels with Direct Touch Control for selecting lighting and chassis functions. It is angled and concave – and thus one of the first exposed curved displays to be installed in a car. This instrument cluster houses three freely configurable round instruments: recognizably Porsche, but in virtual form.

Your central control unit for audio, navigation and communication: redesigned **Porsche Communication Management (PCM)** including online navigation. The PCM display on the **10.9-inch central display** on the dashboard can be individually configured, allowing direct access to the most important functions.

Another digital element is located in the center console, namely the **8.4-inch center console control panel**. This provides access to navigation, media, telephone, settings and Apple CarPlay® via a menu bar which can be disabled. The trunks and charging port doors can also be opened and closed from here. The charging display and battery charge status can also be viewed.

In addition, the Taycan offers an optional **front passenger display**, allowing access to navigation and infotainment functions. And, especially for passengers in the back seats, an optional **5.9-inch touchscreen display is available in the rear**, which can be used to operate comfort features, such as temperature, ventilation and seat heating.



1 Detailed view: 800-volt Performance Battery Plus with cell modules

The key to designing an outstanding drivetrain was the systematic continuation of the purpose-design approach: no compromises with the perfect interaction of drive components.

Two **Permanent Magnet Synchronous Motors** are installed in the Taycan Turbo and Taycan Turbo S – one on each axle – and the 93 kWh performance battery plus is integrated deep into the underbody. The effect: superior driving dynamics and all-wheel drive that can be optimally adjusted to the fluctuation between efficiency and dynamics in the various driving modes.

The concept of the permanent magnet synchronous motor provides high power density, high continuous output and high efficiency in a compact design. A newly developed, automatically switching **two-speed transmission** on the rear axle ensures noticeably improved dynamics.

The interaction of the drive components produces impressive performance figures, both technically and emotionally: with up to **560kW (750 HP) overboost** is activated with Launch Control, both machines accelerate the Taycan Turbo S from a standstill to 60 mph in 2.6 seconds. And this can be repeatedly reproduced: consecutive acceleration is possible, up to a top track speed of 161 mph.

This is due to the performance battery, among other things, which is based on 800-volt technology instead of the usual 400 volts. The effect: improved charging and drive performance with smaller cable cross-sections, which has a positive impact on the overall weight.

Thus, the Taycan delivers high performance. That is E-Performance, as can only be found in a Porsche.

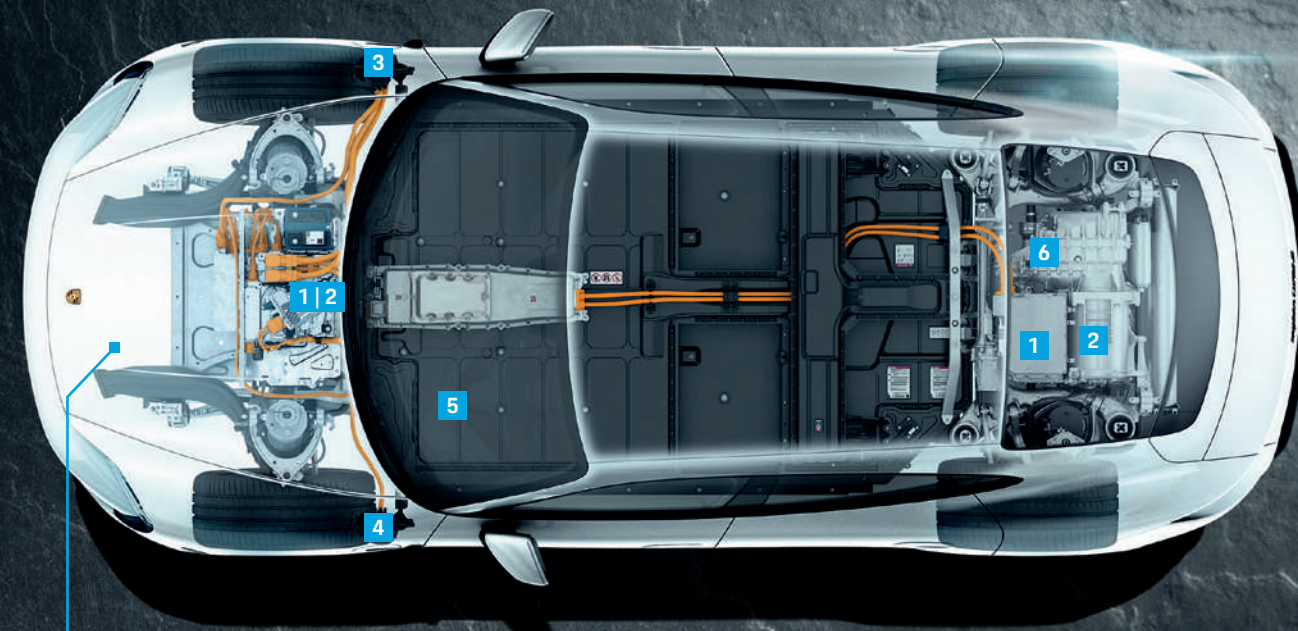

1 Power electronics

2 Permanent Magnet Synchronous Motors

3 Vehicle charge port (AC/DC)

4 Vehicle charge port (AC)

5 800-volt Performance Battery Plus (93 kWh)

6 Two-speed transmission

# Performance.





With recuperation braking from

124 mph

to 0

electrical energy can be recovered for an additional

2.5 miles range.

Performance.

1

The Taycan is fitted with the **Porsche Active Aerodynamics** system, consisting of an adaptive rear spoiler and adjustable cool air intakes, specifically for dynamic driving. Depending on the situation, the rear spoiler extends in three stages: at 56 mph, 99 mph, and 124 mph, it demonstrates where an electric vehicle becomes a sports car and a sports car becomes a Porsche. The alloy wheels are also aerodynamically optimized. Depending on the model, standard 20-inch or even 21-inch wheels have a decisive impact on the design.

Thanks to the **Porsche Surface Coated Brake (PSCB)**, your Taycan decelerates with optimized responsiveness. Or choose the extremely light-weight **Porsche Ceramic Composite Brake (PCCB)** – standard on the Taycan Turbo S. Our high-performance brake has its origins in motorsport and enables short braking distances in even the toughest conditions.

The Taycan also has an efficient recuperation system for recovering braking energy. In this case, the electric motors act as generators if required, resulting in deceleration.

**Porsche Recuperation Management (PRM)** works innovatively and can regenerate up to 90% of braking energy. This means, during active braking, recuperation is enabled first and the mechanical brake is only engaged when stronger braking is required – intelligently controlled by a braking system that is capable of blending. With an outstanding recuperation output of up to 265kW, energy can be fed back into the battery in the Taycan. Or to be more precise: during sporty, everyday driving, for example, you will achieve up to a third of your range exclusively from recuperation. With recuperation braking from 124 mph to 0, electrical energy can be recovered for a range of up to 2.5 miles.

In addition to the brake pedal, we have also included the accelerator pedal in PRM, optimally combining sporty driving with efficiency. The three recuperation modes can be conveniently adjusted via a button on the steering wheel, for maximum control and personalization.

Acoustically too, the Taycan provides an entirely new experience: it makes virtually no noise – all you can hear is the exterior sound that meets the legal requirements. For a unique acoustic accompaniment to dynamic driving, there is also the standard on Turbo S, **Porsche Electric Sport Sound** – a system whose innovative character makes the vehicle's own drive sound appear even more emotional, both outside and inside. The ideal feedback for your right foot.

Experience Porsche Electric Sport Sound here: [www.porsche.com/taycan-sound](http://www.porsche.com/taycan-sound)

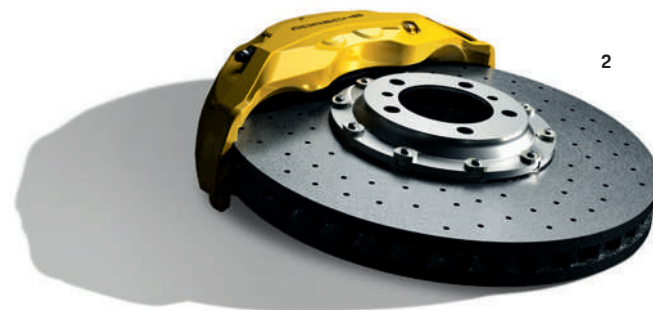

2

- 1 21-inch Mission E Design wheel painted in exterior color **Porsche Exclusive Manufaktur**
- 2 Porsche Ceramic Composite Brakes (PCCB): Rotor diameter: 420mm front and 410mm rear

As with any Porsche, the chassis is also the supreme technical discipline in the Taycan. It uses all the Porsche chassis technologies to harmonize performance and comfort. The low center of gravity due to the underbody battery is a distinct advantage when it comes to handling.

Intelligent chassis systems, most of which have already been proven in other Porsche models, help it to transfer its potential to the road:

**Adaptive air suspension** ensures a balance between comfort and performance, optimum aerodynamics and, last but not least, an improved drag coefficient: increased range with maximum performance.

**Porsche Active Suspension Management (PASM)** provides additional stability: an electronic damping control system that adjusts the damping force, based on current road conditions and your driving style. This prevents annoying body roll and improves comfort in all seats.

**Rear-axle steering** steers the rear wheels in the same or the opposite direction to the front wheels, depending on the speed. This has the virtual effect of shortening or extending the wheelbase – depending on the situation. For increased stability at high speed, improved lateral acceleration on country roads and a reduced turning circle in everyday situations.

The roll stabilization of **Porsche Dynamic Chassis Control Sport (PDCC Sport)** also ensures sporty dynamics. This system, which is also used in other model ranges, almost entirely offsets lateral body inclination, thereby allowing the wheels to hold the road better. It also reduces lateral instability on uneven ground.

**Porsche Torque Vectoring Plus (PTV Plus)** enhances driving dynamics and stability. Depending on the steering angle and driving speed, accelerator pedal position, yaw rate and speed, it improves the steering behaviour and accuracy by precisely and agilely applying brake pressure to the left or right rear wheel.

At high speeds and when accelerating out of corners, the electronically controlled rear differential with fully variable torque distribution also acts to provide greater driving stability and traction.

To ensure that these systems interact perfectly, we have developed **Porsche 4D Chassis Control**: an integrated chassis control system that directs and synchronizes the control units of the individual chassis components – for optimally balanced power electronics in every situation.

- 1 20-inch Taycan Turbo Aero wheel
- 2 20-inch Sport Aero wheel
- 3 21-inch Mission E Design wheel painted in exterior color  
*Porsche Exclusive Manufaktur*
- 4 21-inch Taycan Exclusive Design wheel with Carbon Fiber aeroblades  
*Porsche Exclusive Manufaktur*

Other alloy wheels are available in the Porsche Car Configurator.

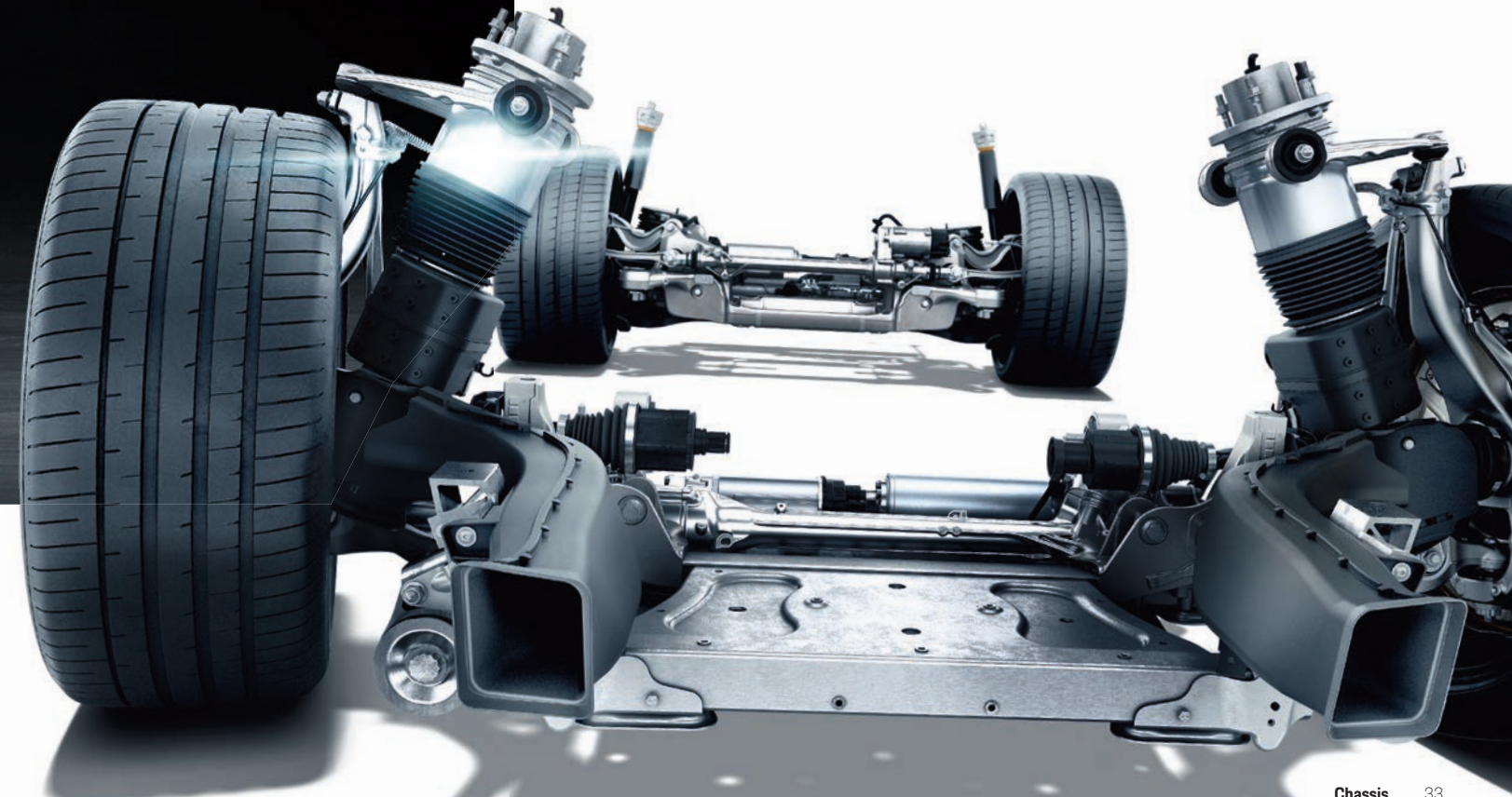

# Chassis.



Driving a sports car means being able to fully focus on the driving experience. While being confident that nothing will tarnish this.

**Adaptive cruise control (ACC)** automatically adjusts the distance from the vehicle ahead – for added comfort on country roads and highways.

As part of intelligent **Porsche InnoDrive including adaptive cruise control**, the system increases the prediction horizon to up to 1.8 miles. With the aid of navigation data and information supplied by the radar and video sensors, it determines speed limits and topographical road features long before you reach them and modifies the speed and gearshift strategy to suit the selected driving mode. All according to Porsche standards. So you get more driving pleasure and efficiency from every metre.

**Active Lane Keeping**, which uses longitudinal and lateral control to help keep the Taycan in lane and regulate the distance from vehicles in front, is also an integral part of this system – as is **Traffic Jam Assist**, which helps keep the vehicle in the middle of the lane on congested roads, for greater comfort on longer journeys.



**Lane Change Assist** indicates whether a vehicle is in your blind spot as you move to change lanes – extremely practical when driving on the motorway. And at night, **Night Vision Assist** uses an infrared camera to provide support – pedestrians and wildlife are displayed as thermal images and also highlighted in color.

**Porsche Entry & Drive** allows you to leave your car key in your pocket, by recognizing the encrypted access code stored on the key. The Taycan can be conveniently started using the electric power button to the left of the steering wheel or by simply selecting a gear.

**Surround View** ensures optimum care when parking and maneuvering using one hand. Making every inch in the Taycan a driving experience.

See Important Limitations of Assistance Systems



# Assistance systems.

In terms of charging time and range, the Taycan also demonstrates what makes a genuine Porsche. Because we believe that a sports car should be ready to set off at all times, we do our utmost to facilitate simple charging that is integrated into everyday life. Because the only thing you should think about is where to go next.

Our charging concept starts with the vehicle: the Performance Battery Plus with the latest lithium-ion technology is based on 800-volt architecture and, therefore, on a similar system to our endurance race car, the 919 Hybrid. Higher voltage means not only perceptibly more power and less weight, thanks to reduced cable size, but above all shorter charging times.

Because we not only think about the product, but also about the environment in which it is used, Porsche is involved in the development of a nationwide charging infrastructure: both with its own solutions and together with partners – along highways and interstates, for example.

Today, several thousand fast charging options are already available around the world. In conjunction with the Porsche Charging Service, we will enable you to charge your vehicle at a constantly growing network of Electrify America 800V DC fast charging stations for a period of three years, for free.<sup>1)</sup>

**Porsche Turbo Charging** at authorized Porsche dealers further expands the Porsche charging network. Thanks to the on-board DC-charger with 50kW (optionally also with 150kW), you can also conveniently use public 400-volt charging stations.

Added to this are numerous alternating current (AC) charging options, at restaurants and hotels, as well as in many city centers. You can conveniently use any charging point via the **Porsche Charging Service** (part of the Porsche Connect app).

All this makes your Taycan not only future-proof, but also suitable for everyday use.

<sup>1)</sup> Unlimited non-consecutive 30 minute sessions.

# Charging concept.



Charging in your own garage is the most obvious solution for many, because it can easily be integrated into their everyday routine. To do this, open the **Power Charge Port Cover**<sup>1)</sup> and connect the charging cable to your car.

Use the standard **Mobile Charger Plus**<sup>2)</sup>, connected to your home's 240V NEMA 14-50 outlet, to charge the vehicle. Or optionally charge using the intelligent Mobile Charger Connect with touchscreen. You can also conveniently attach the Mobile Charger Connect to your garage wall in the optionally available charging dock. The Porsche Connect app allows you to access information about the remaining charge time or charge level.

To enable you to quickly and easily charge your Taycan at home, we provide the **Home Energy Manager**<sup>2)</sup>: an intelligent control unit, installed in the home electrical panel, which constantly communicates with your charger. It makes sure that your household electric appliances are supplied with sufficient energy while your car is being charged in the garage.

However, not only charging at home, but also charging on the road, should be undertaken intuitively and

seamlessly. Which is why we already offer a network of several thousand charging facilities, together with partners such as **IONITY** and **Electrify America**.

In addition, our network of efficient **Porsche Turbo Chargers** is steadily growing. You can already charge your Taycan with up to 270kW at these 800-volt charging stations at many Porsche dealers.

On the road, intelligent in-car systems assist with efficient range management. The **Charging Planner** plans your route, including charging stops.

Furthermore, you can use the **Porsche Intelligent Range Manager** optionally available in to precisely adapt relevant systems on long journeys with active navigation, so as to minimize travel time, including charging stops.

Thanks to the Porsche Charging Service, charging at public chargers is even easier: the **Porsche Connect app** allows you to locate charging stations and pay your bill. Charging is conveniently administered and invoiced via your **Porsche ID account**.

Current charging facilities can be accessed at any time via Porsche Communication Management in your Taycan or online at [www.porsche.com/taycan-charging](http://www.porsche.com/taycan-charging)

1) Optionally available; standard on the Taycan Turbo S.

2) Available from mid-2020 at the earliest.



Charging at home and on the road.

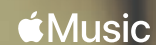

All your favorite music on the go.

Listen to 50 million songs ad-free effortlessly in your Taycan.



# Porsche Connect.

Connecting you to your Taycan and your Taycan to the world – **Porsche Connect**. The system extends the existing vehicle functions with intelligent digital services and apps. For the first time, you can also purchase individual functions after taking delivery of your car – depending on its configuration – via **Function on Demand (FoD)** in the Porsche Connect Store.

The basis for Porsche Connect is the **LTE communication module**. It ensures an optimized data connection in your Taycan.

In the Taycan, Porsche Connect has been expanded to include innovative services. Above all, **Porsche Voice Pilot**. Simply say “Hey Porsche” and your car will then respond to statements such as “I’m cold”. Multimodal operation using both touch and voice commands is also possible: point to the map and say “Start navigation”.

When on the road, **Navigation Plus** continually retrieves real-time traffic information, so that you can avoid traffic jams and save time.

Relevant charging pedestals are synchronized for the **Charging Planner**, which allows you to plan routes to more distant destinations, including charging stops, and continuously updates the route.

You can keep an eye on this while driving using the **route monitor**. This provides a clear overview of the relevant real-time traffic, range and charging stop information – allowing you to fully focus on the pleasure of driving. With the help of **My Porsche**, you can also send the planned route to your car in advance or contact your Porsche dealer. You will receive your very own **Porsche ID** to use this service.

In addition, it supports **Apple CarPlay**® which is a smarter, safer way to use your iPhone® in your Taycan. Apple CarPlay® lets you get directions, send and receive messages, and more on the built-in PCM or using Siri® voice control – to stay fully focused on the road.

Another Taycan highlight introduces the seamless integration of **Apple Music**® directly in the PCM. Simply tap on Apple Music® to stream over 50 million songs ad-free and curated playlists for any driving mood. Or create your own custom station on Apple Music® from any radio song. New Taycan owners receive up to 3 months free of Apple Music®.<sup>1)</sup>

To make your future workshop visits even more efficient, we will soon be offering **online software updates** for your Taycan. So your car always has the latest software version.



<sup>1)</sup> Apple Music® requires a subscription.

21-inch Taycan Exclusive Design wheels with Carbon Fiber aeroblades

Model designation on doors in black

LED-Matrix Design Headlights in Glacier Blue incl. Porsche Dynamic Light System Plus (PDLS+)

21-inch Mission E Design wheels painted in exterior color

Accent package painted in exterior color

Exterior mirror upper trim in Carbon Fiber



Model designation on doors in black

- Light strip with 'PORSCHE' logo in Glacier Blue and 'Welcome' function
- Model designation painted in high gloss black
- SportDesign package in Carbon Fiber<sup>1)</sup>

SportDesign package in Carbon Fiber<sup>1)</sup>

'PORSCHE' logo LED door projectors

SportDesign package



# Porsche Exclusive Manufaktur.

## The Taycan Turbo in Dolomite Silver Metallic and Mamba Green Metallic.



<sup>1)</sup> Available from mid-2020 at the earliest.

## Exterior colors.<sup>1)</sup>

### Solid colors.



White



Black

### Metallic colors.



Jet Black Metallic



Volcano Grey Metallic



Carrara White Metallic



Gentian Blue Metallic



Dolomite Silver Metallic



Mamba Green Metallic



Frozenblue Metallic



Mahogany Metallic



Frozenberry Metallic



Cherry Metallic



Coffee Beige Metallic

### Special colors.



Carmine Red



Neptune Blue



Chalk



Ice Grey Metallic

## Interior.<sup>1)</sup>

### Leather interior, smooth-finish leather.



Black



Slate Grey



Blackberry

### Leather interior in two-tone combination, smooth-finish leather.



Black and Bordeaux Red



Black and Limestone Beige



Black and Chalk



Blackberry and Slate Grey

### Leather-free interior.



Black



Graphite Blue



Slate Grey

### Leather-free interior in two-tone combination.



Black and Slate Grey



Graphite Blue and Slate Grey

### Leather interior, Olea club leather.



Truffle Brown



Basalt Black

### Leather interior Olea club leather in two-tone combination.



Basalt Black and Atacama Beige



Basalt Black and Meranti Brown

### Interior packages.



Matte Carbon Fiber  
*Porsche Exclusive Manufaktur*



Aluminum Rhombus



Dark paldao open-pored

### Accent packages.



Black



Dark Silver



Neodyme



Painted in exterior color  
*Porsche Exclusive Manufaktur*

# Colors.

<sup>1)</sup> For all available colors and interiors, please visit [www.porsche.com/taycan-visualizer](http://www.porsche.com/taycan-visualizer) or your authorized Porsche dealer.

### Porsche E-Performance drive

Model Battery variant	<b>Turbo S</b> Performance Battery Plus	<b>Turbo</b> Performance Battery Plus
Electric motor, front axle	Permanent Magnet Synchronous Motor	Permanent Magnet Synchronous Motor
Electric motor, rear axle	Permanent Magnet Synchronous Motor	Permanent Magnet Synchronous Motor
Power (kW/HP)	Up to 460/616	Up to 460/616
Overboost Power (kW/HP) with Launch Control	Up to 560/750	Up to 500/670
Maximum torque with Launch Control (lb-ft.)	774	626

### Performance

Top track speed	161	161
Acceleration 0–60 mph (seconds) with Launch Control	2.6	3.0

# Technical data.

### Charging

Model Battery variant	<b>Turbo S</b> Performance Battery Plus	<b>Turbo</b> Performance Battery Plus
Gross battery capacity (kWh)	93.4	93.4
Net battery capacity (kWh)	83.7	83.7
Charging time for AC (alternating current) with 9.6kW, from 0 to up to 100% (h)	10.5	10.5
Charging time for DC (direct current) with 50kW, from 5% to up to 80% (min)	93	93
Charging time for DC (direct current) with 270kW, from 5% to up to 80% under optimum conditions <sup>1)</sup> (min)	22.5	22.5

<sup>1)</sup> Optimum conditions: CCS fast-charging pedestal with >270kW, >850V, battery temperature 86°F to 95°F and initial charge status 5%.

### Dimensions

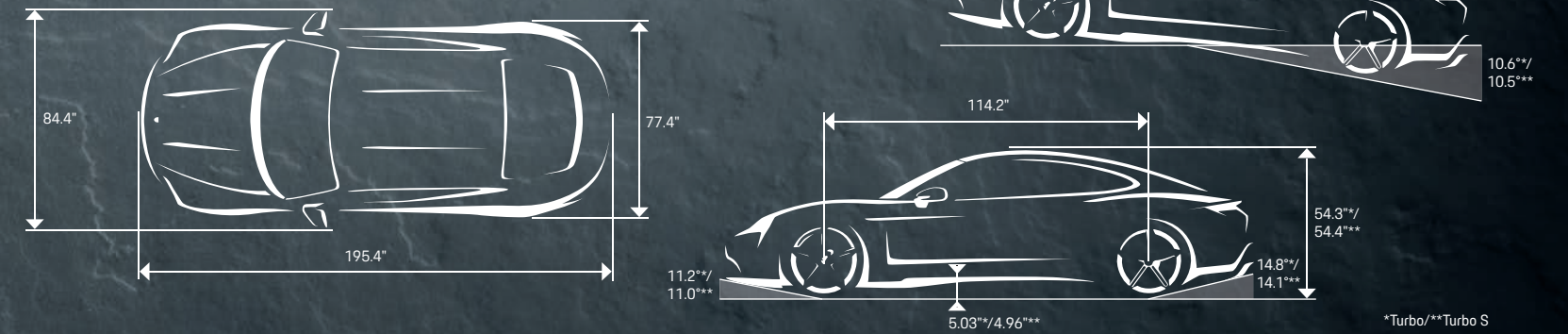

## Chassis

Model	<b>Turbo S</b>	<b>Turbo</b>
Battery variant	Performance Battery Plus	Performance Battery Plus
Turning circle diameter (ft)	–	36.7
Turning circle diameter in conjunction with rear-axle steering (m)	34.1	34.1
Brakes	Ten-piston aluminum monobloc fixed brake calipers at the front, four-piston aluminum monobloc fixed brake calipers at the rear	Ten-piston aluminum monobloc fixed brake calipers at the front, four-piston aluminum monobloc fixed brake calipers at the rear
Brake discs, front axle diameter/thickness (mm)	420/40	415/40
Brake discs, rear axle diameter/thickness (mm)	410/32	365/28

## Weights

Curb Weight (lb)	5,121	5,132
Maximum permissible roof load with Porsche roof transport system (lbs)	75	75

## Volume

Luggage compartment, rear (cubic feet)	12.9	12.9
Luggage compartment, front (cubic feet)	2.8	2.8

## Important Limitations of Assistance Systems.

### A Few Important Words About Porsche Driver Assistance Systems ...

- None of Porsche's Driver Assistance Systems can prevent accidents or loss of control.
- No Driver Assistance System is ever a substitute for attentive driving. It is the driver's responsibility to be observant and in control of the vehicle at all times.
- Please see your vehicle's owners' manual for further details about, and important limitations of, each of the specific systems described below.

### ACTIVE LANE KEEP

- Active Lane Keep may not detect lane markings in certain road, weather, and driving conditions.
- System is available only in conjunction with active Adaptive Cruise Control (ACC).

### ADAPTIVE CRUISE CONTROL

- Adaptive Cruise Control should not be used in unfavorable road conditions and poor weather conditions.
- Adaptive Cruise Control automatically maintains a set speed and a set distance at a speed above approximately 19 mph – 130 mph.

### AUTO EMERGENCY STOP

- Auto Emergency Stop depends in part on signals from the worldwide Global Positioning Satellite network. The vehicle's electronic system and data connection, and existing wireless satellite technology, must be available and operating properly for the system to function fully.

### PORSCHE DYNAMIC LIGHTING SYSTEM

- Static cornering lights – At speeds of up to 80 mph static cornering light is switched on when the steering wheel is turned.
- Dynamic cornering light – Above a speed of around 3 mph, the low beam or high beam headlights are swiveled in the direction of the curve to illuminate the road more clearly, depending on the speed of the vehicle and the extent to which the steering wheel is turned.

### PORSCHE DYNAMIC LIGHTING SYSTEM (PLUS)

- High Beam Assistant is switched on at between 20 mph and 37 mph.

### HEAD-UP DISPLAY

The driver's view of the information in the head-up display may be impaired by the following factors:

- Sunglasses with certain polarizing
- Wet roads
- Unfavorable lighting conditions

### PORSCHE INNO DRIVE INCLUDING ADAPTIVE CRUISE CONTROL

- InnoDrive depends in part on signals from the worldwide Global Positioning Satellite network. The vehicle's electronic system and data connection, and existing wireless satellite technology, must be available and operating properly for the system to function fully.
- Construction zones, traffic flow, and other road system changes are beyond the control of Porsche Cars North America. Complete detailed mapping of lanes, roads, streets, toll roads, tollbooths, highways, road signs, and so forth is impossible. Therefore, you may encounter discrepancies between the mapping and the actual location and conditions you encounter. Always pay careful attention to the road, give precedence to directional signs on the road and not the system, and do not drive while distracted.

### INTERSECTION ASSIST

- This system detects only other vehicles, but not people, cyclists, or animals, for example.

### LANE CHANGE ASSIST

- Lane Change Assist operates above a driving speed of approximately 10 mph.
- Rear Turn Assist – Supports Lane Change Assist only when driving off and on the vehicle side on which the turn signal was actuated. Active at speeds up to approximately 12 mph.

### LANE KEEP ASSIST WITH TRAFFIC SIGN RECOGNITION

- Lane Keep Assist may not detect lane markers in certain road, weather, or driving conditions. Please see owner's manual for further details and important warnings about limitations of the system.
- This system depends in part on signals from the worldwide Global Positioning Satellite network. The vehicle's electronic system and data connection, and existing wireless satellite technology, must be available and operating properly for the system to function fully.
- Traffic Sign Recognition may not always see or understand every sign. It depends upon a clear, unobstructed view of the road ahead, and well-maintained and clean road signs of generally recognized types.
- Lane Keep Assist may be passive if the vehicle speed is below the activation speed of approximately 40 mph.

### NIGHT VISION ASSIST

- Night Vision Assist does not prevent accidents. The system may not represent objects as the eye does. It will not detect persons or animals under certain lighting and temperature conditions, and it cannot detect inanimate objects in the road.
- Night Vision Assist detects persons and animals when it is sufficiently dark and at an ambient temperature below 82°.

### PARKASSIST (FRONT AND REAR) WITH VISUAL AND AUDIBLE WARNING

- ParkAssist cannot detect sound-absorbing obstacles such as powdery snow, clothing made from fabric, skin or fur; sound-reflecting obstacles such as glass surfaces, flat painted surfaces, very thin obstacles, i.e. thin posts or obstacles above and below the sensors.
- ParkAssist is activated automatically up to a speed of approximately 10 mph, and when operational readiness is established in the following situations: Reverse gear engaged or distance in front is less than approximately 32 in. or rolling backward is detected. Reversing camera – The objects shown by the camera appear distorted. The image from the rear view camera does not show the entire area behind the vehicle. Surround View – The objects shown by the cameras appear distorted. Many of the screen windows do not show the entire area around the vehicle.

### TRAFFIC JAM ASSIST

- Traffic Jam Assist supports the driver when driving in traffic jam situations or in slow-moving traffic in a speed range below approximately 40 mph.

### WARN AND BRAKE ASSIST (COLLISION AND BRAKE ASSIST)

- Warn and Brake Assist cannot prevent most collisions, although it may help to reduce their severity.
- In addition, Warn and Brake Assist may not detect every object in the road.
- The system may not operate if certain evasive maneuvers are performed by the driver.
- The system is available as of walking speed and can react to pedestrians or cyclists up to a speed of approximately 53 mph.
- The function may be restricted or unavailable up to 10 seconds after establishing operational readiness, and other instances.

### WET MODE

- WET Mode depends on sensors in the front wheel arches. It cannot provide assistance if there is too much water present, if the vehicle is driving too fast, or if the sensors are obstructed by dirt, excessive water or other obstructions.
- WET Mode cannot detect or prevent aquaplaning.

Not all the Driver Assistance Systems described in this brochure are installed or available on every model. Some Driver Assistance Systems are optional at extra cost. Some Driver Assistance Systems require the selection of other systems or options at additional cost. Some Driver Assistance Systems are not available in combination with others. Ask your authorized Porsche dealer for details about the models and systems in which you are interested.

# Important information.

## I. Battery

A lithium-ion battery is subject to physical and chemical ageing, as well as wear and tear. This reduces the battery capacity, depending on the usage pattern and environmental conditions, resulting in a reduction in range and an increase in charging times as the battery ages. Due to the effect of temperature on battery and charging performance, as well as battery life, please consider the following when parking, driving and charging your car:

- If possible, avoid permanent ambient temperatures of over 86°F, such as prolonged parking in direct sunlight.
- If you cannot avoid ambient temperatures of over 86°F when stationary, connect the vehicle to the mains supply after use and charge the high-voltage battery with AC (alternating current) to a maximum charge status of 85%.
- If the car is left stationary for more than two weeks, the ambient temperature should, if possible, be between 32°F and 68°F and the battery charge status maintained between 20% and 50% during this time.
- For the shortest possible charging time, a battery temperature of approx. 86°F to 95°F is ideal.
- If charging the car on a daily basis, the maximum charge status of the high-voltage battery should be set to approx. 80%.

## II. Charging

The specified charging outputs and times are dependent on various factors: in general, the charging output and time can vary due to physical and chemical limits, depending on factors such as the available output of the country-specific energy infrastructure, the customer's own domestic installation, the temperature, interior pre-conditioning and charging status, as well as the age of the battery. Charging times may therefore be significantly higher than those specified. To achieve the optimum value of the specified DC charging time (DC = direct current) for a charge status increase from 5 to 80%, a CCS (combined charging system) fast-charging pedestal with > 270kW and > 850V is required, as well as a battery temperature of 86°–95°F. The charging status when commencing charging must not exceed 5%. For physical and chemical reasons, the charging speed decreases as the battery approaches its full capacity. Therefore, it usually makes sense to use fast DC charging to charge the battery up to 80% or up to the required range. The predominant use of CCS fast-charging pedestals leads to a long-term increase in charging times. For regular fast DC charging, we recommend a maximum charging output of 50kW. When charging in a residential environment, AC charging (AC = alternating current) is recommended. Using an (AC) 240V circuit will result in improved efficiency and a much shorter charging time compared to using a household socket.

## III. Drive power

In general, the available drive power in battery-operated electric cars depends on various factors, such as the duration of the required performance, as well as the battery voltage and temperature. The specified power is available for at least 10 seconds and the specified overboost with standard launch control for at least 2.5 seconds. Extremely sporty driving or charging at a fast-charging pedestal can result in an increase in battery temperature and, therefore, in temporarily reduced drive power. Due to the physical environment, the maximum power required to achieve the specified acceleration values can be repeatedly produced, but usually not consecutively.



© Dr. Ing. h.c. F. Porsche AG is the owner of numerous trademarks, both registered and unregistered, including without limitation the Porsche Crest®, Porsche®, Boxster®, Carrera®, Cayenne®, Cayman®, Macan®, Panamera®, Spyder®, Taycan™, Tiptronic®, VarioCam®, PCM®, PDK®, 911®, 718®, RS®, 4S®, 918 Spyder®, FOUR UNCOMPROMISED®, and the model numbers and distinctive shapes of the Porsche automobiles such as, the federally registered 911 and Boxster automobile.

The third party trademarks contained herein are the properties of their respective owners. All text, images, and other content in this publication are protected by copyright.

No part of this publication may be reproduced in any form or by any means without prior written permission of Porsche Cars North America, Inc.

Porsche Cars North America, Inc. believes the specifications to be correct at the time of printing. However, specifications, standard equipment and options are subject to change without notice. Some options may be unavailable when a car is built. Some vehicles may be shown with non-U.S. equipment. Please ask your authorized Porsche dealer for advice concerning the current availability of options and verify the optional equipment that you ordered.

Porsche recommends seat belt usage and observance of traffic laws at all times.

© 2019 Porsche Cars North America, Inc.  
One Porsche Drive  
Atlanta, GA 30354  
[www.porscheusa.com](http://www.porscheusa.com)

Effective from: 09/2019  
Printed in Germany  
WSLT1901000123 EN/US